

Towards a method for detecting the potential genotoxicity of nanomaterials



Deliverable 4.6: Dustiness of NANOGENOTOX nanomaterials
using the NRCWE small rotating drum
and the INRS Vortex shaker

Key intrinsic physicochemical characteristics of
NANOGENOTOX nanomaterials

October
2012



WP 4: Physicochemical Characterization of Manufactured Nanomaterials (MNs) and Exposure Media (EMs)

Deliverable 4.6: Dustiness of NANOGENOTOX nanomaterials using the NRCWE small rotating drum and the INRS Vortex shaker

—

Key intrinsic physicochemical characteristics of NANOGENOTOX nanomaterials

Deliverable leader: NRCWE

Keld Alstrup Jensen
The National Research Centre for the Working Environment (NRCWE),
Lersø Parkallé 105, DK-2100 Copenhagen, DENMARK



National Research Centre
for the Working Environment



Workflow	
<p>Author(s) Olivier Witschger, Bernard Bianchi and Sebastian Bau (INRS)</p> <p>Marcus Levin, Ismo K Koponen, and Keld Alstrup Jensen (NRCWE)</p>	<p>Reviewer(s) WP Leader: Keld Alstrup Jensen (NRCWE) Coordinator: Nathalie Thieriet (ANSES)</p>

Document status:	v.1.0	first draft	Creation date:	08/06/2011
	v.1.2	second draft	date:	31/10/2012
	v.1.3	final revision	date:	02/11/2012
	V.1.4	comment from NGTX coordination tea	date:	11/02/2013
	V.1.5	Final revision by authors	date:	20/03/2013

Confidentiality level of the deliverable		
PU	Public	PU
CO	Confidential, only for members of the consortium (including the Commission Services)	

1	INTRODUCTION.....	3
2	NANOMATERIALS (NM) AND INFORMATION GIVEN BY SUPPLIERS	5
3	EXPERIMENTAL SETUP	8
3.1	THE SMALL ROTATING DRUM (SD) METHOD	8
3.2	THE VORTEX SHAKER (VS) METHOD	10
4	RESULTS.....	18
4.1	SMALL ROTATING DRUM (SD) METHOD	18
4.2	VORTEX SHAKER (VS) METHOD	21
4.3	COMPARISON BETWEEN SD AND VS METHOD.....	32
5	CONCLUSION.....	34
6	REFERENCES	35



1 Introduction

The release of particles from bulk nanomaterial powders in surrounding air is an important consideration for worker exposure and the design and operation of many industrial or research processes (Liden, 2006). It is therefore important to obtain data about the propensity of bulk nanomaterials powders to be released as particles, the so called dustiness, allowing risks to be evaluated, controlled and minimized (Schneider and Jensen, 2009).

It is for these reasons that OECD considers that dustiness is one of the endpoints to take into account when testing nanomaterials for human health issues and that it contributes to a proper risk assessment of the nanomaterials (OECD, 2012). One can also note that the RIP-oN¹ 2 project on the key aspects of the implementation of REACH with regard to nanomaterials considers as advantageous to have accurate information on dustiness as part of the Integrated Testing Strategy for properties relevant for nanomaterials (RIP-oN 2, 2011).

It is important to note that dustiness is not an intrinsic physical or chemical defined property of a powder, but its level depends on as well as characteristic properties of the powders and the activation energy in the simulated handling. Therefore different values may be obtained by different test methods (test apparatus, operation procedure, sampling and measurement strategy, etc.).

This report presents the final results and description of the standard operation procedures (SOPs) for analysis of nanomaterial dustiness using two different alternative procedures to the EN15051 standard.

The first procedure is the downscaled rotating dustiness drum, which is a miniaturized version of the EN15051 drum (Schneider and Jensen, 2008). The miniaturized drum is generally referred to as the small drum (SD) and test comparisons of inhalable dust with the EN15051 in the NANODEVICE project has shown that the results is very comparable (Jensen *et al.*, 2012).

The second procedure is the Vortex shaker method, which consists of a centrifuge tube continuously agitated by vibration in which the test powdered material is placed. Originally proposed by Baron *et al.* (2002), this method called the VS method was also used later by Isamu *et al.* (2009). More recently, INRS has developed this approach VS, particularly in the context of a collaborative project within the network PEROSH (Witschger *et al.*, 2011).

Among the useful features of the SD and the VS approaches is that between less than 1/10th of a gram to several grams is needed for a test, compared to the traditional methods describes in the EN15051 standard that require several hundred of grams. In addition, their smaller size makes them easier to place in an approved fume cupboard or safety cabinet; it is an important point - the safety of experimenters - which was included in this project.

The results have been generated during the first two years of the Joint Actions project, NANOGENOTOX, which is funded by the EAHC (Executive Agency for Health and Consumers). Temporary results and SOPs have previously been reported in Guiot *et al.* (2011). This report, together with six other topical reports and a summary report officially fulfils deliverable 4 of the

¹ REACH Implementation Project on Nanomaterials

project, including analysis of the hydrochemical reactivity of the selected nanomaterials. The complete final report series on physico-chemical characterization are listed hereafter:

- D4.1: Summary report on primary physiochemical properties of manufactured nanomaterials used in NANOGENOTOX
- D4.2: Transmission electron characterization of NANOGENOTOX nanomaterials
- D4.3: Crystallite size, mineralogical and chemical purity of NANOGENOTOX nanomaterials
- D4.4: Determination of specific surface area of NANOGENOTOX nanomaterials
- D4.5 Surface charge, hydrodynamic size and size distributions by zetametry, dynamic light scattering (DLS) and small-angle X-ray scattering (SAXS) in optimum aqueous suspensions for titanium and silicon dioxide
- D4.6: Dustiness of NANOGENOTOX nanomaterials using the NRCWE small rotating drum and the INRS Vortex shaker
- D4.7: Hydrochemical reactivity, solubility, and biodurability of NANOGENOTOX MN.

Note that the results in the current report are considered the final data. The SOPs used to achieve the data are presented in the methods section.

The objective of this report is to analyze the propensity of the NANOGENOTOX nanomaterials to generate fine dust during simulated agitation of raw powder. In this project, nanomaterials powders were compared with each other according to their index of dustiness. Two indexes have been defined, one based on the number of particles emitted, and the other according to the mass of particles emitted. In addition, we were able to compare the results between the two fundamentally different methods (and SD VS) since many nanomaterials powders were tested with both methods.

2 Nanomaterials (MN) and information given by suppliers

The tested NANOGENOTOX materials include 6 titania-(TiO₂)-based products (Table 1), 5 silica products (Table 2) and 6 multi-walled carbon nanotubes (Table 3). The Synthetic Amorphous Silica MNs is denoted SAS and SiO₂ in accord with a decision in the NANOGENOTOX Consortium. For titania- and carbon nanotube-based MN, the short used forms are TiO₂ and CNT.

Table 1: TiO₂ Nanomaterials included in the NANOGENOTOX project.

JRC code	Special notes	Phase	Applications	Purity wt%	Particle size	BET (m ² /g)	Impurity / coating
NM-100	Dry-milled	anatase	paper loadings, rubber, cosmetics, adhesives, low cost interior paints	98.5	200-220 nm	-	-
NM-101		anatase	semiconductor catalyst for use in photocatalytic processes	91(99)*	< 10 nm	>250	9%*
NM-102		anatase	photocatalytic	95	-	90	-
NM-103	hydrophobic	rutile	cosmetics (sun care, colour), pharma, food	89	20 nm	60	Al ₂ O ₃ 6%, silicone - Dimethicone 2%
NM-104	hydrophilic	rutile		90	20 nm	60	Al ₂ O ₃ 6% - Dimethicone 2%
NM-105		rutile/anatase	catalysis, heat stabilizer	-	21 nm	50+/- 15	-

* calcination causes loss of 9 wt% and the residual is 99% pure

Table 2: SAS Nanomaterials included in the NANOGENOTOX project.

JRC code	Special notes	Phase	Applications	Purity wt%	Particle size	BET (m ² /g)	Impurity / coating
NM-200	precipitated	PR-A-02	food, processing	-	15 nm	220	10 SiO ₂ 1 H ₂ O, 2% soluble salts
NM-201	precipitated	PR-B-01	reinforcement, mechanical and optical properties and process	-	-	160	10 SiO ₂ 1 H ₂ O, 1,5% soluble salts
NM-202	pyrogenic	PY-AB-03	inks, adhesives, cosmetics, reinforcement, powder process, food, pharmaceuticals	>99.8	-	170-230	-
NM-203	pyrogenic	PY-A-04	food, cosmetics pharma, reinforcement	-	12 nm	200+/-25	hydrates?
NM-204	Precipitated	-	Food	-	-	140	-

Table 3: Carbon nanotubes Nanomaterials included in the NANOGENOTOX project.

JRC code	Special notes	Phase	Applications	Purity wt%	Particle size	BET (m ² /g)	Impurity / coating
NM-400	CCVD**	MWCNT	structural composite and energy applications	-	~1.5 um long	250-300	10 wt% oxides/coated with pyrogenic carbon
NM-401	CCVD**	MWCNT	structural composite and energy applications	-	5-15 um long	40-300	~2% amorph. carbon
NM-402	CCVD**	MWCNT	structural composite and energy applications	-	0.1-10 um long	-	<10 wt%
NM-403	CCVD**	MWCNT	structural composite and energy applications	-	1->10 µm long	-	-
NRCWE-006	CCVD**	MWCNT	energy / Li-ion battery	>99.5	segments; 3-5 um long	24-28	
NRCWE-007	CCVD**	MWCNT	structural composites etc.	-	8-15 nm OD; 10-50 um long	233	ca. 3.2 wt% C impurities/ < 1.5 wt% ash (Al, Cl, S)

**CCVD : Catalytic Chemical Vapour Deposition

3 Experimental setup

Dustiness testing was completed using two different agitation methods; namely the small rotating drum (SD) method and the Vortex shaker (VS) method.

Dustiness is defined as the propensity of a material to emit dust during agitation and standardized testing methods have been established (EN15051). The latter, as described in the standard, does not directly apply to nanomaterials. Among the reasons for this, there is that current EN 15051 methods:

- Use experimental setups relatively bulky, which limit their use in collective protection equipment such as fume cupboards.
- Require a large amount of material, typically above 500 g.
- Are associated with mass-based protocols that give no indication of :
- The determinants of expected potential toxicity such as the number of particles, their size distribution, their shape.
- The presence or absence of sub-100 nm particles, or even submicron particles.

In this work determination of dustiness in respirable size-fractions were combined with number concentration and size-distribution analysis of the dust particles for both SD and VS methods. In addition, as was possible in the existing protocol SD method, the inhalable fraction was systematically measured. In few of the tests conducted with the VS method, electron microscopy (EM) observations were performed. Finally, particle-size distributions data are reported from measurements using Electrical Low-Pressure Impactor (ELPI™ Classic) for the Vortex shaker (VS) method, and Fast Mobility Particle Sizer (FMPS) and Aerodynamic Particle Sizer (APS) for the small rotating drum (SD) method. This difference is not due to a lack of harmonization between the two laboratories (NRCWE and INRS) but because the two laboratories did not have the same equipment when testing MN samples within the project.

3.1 The Small rotating Drum (SD) method

The small rotating drum (Figure 1) was designed as a downscaled version of the EN 15051 rotating drum while maintaining important test parameters. This enabled testing of smaller material amounts (~6g). The drum consists of a cylindrical part [internal diameter (i.d.) 16.3 cm, length 23.0 cm, volume 4.80 l] with a truncated cone at each end (half angle 45°, length 6.3 cm, volume 1.13 l). The total volume of the drum is 5.93 l. The drum was made of stainless steel and all inside surfaces were polished to 450 ± 50 gloss units to minimize surface adhesion and to facilitate cleaning. The drum was electrically grounded as prescribed by EN 15051. The drum contains three lifter vanes (2 x 22.5 cm). In EN 15051, a 1-min rotation at 4 rpm and eight lifter vanes are prescribed. Therefore, the present drum was operated at 11 rpm to obtain the same number of powder parcels falling per minute as in the EN 15051 test (Schneider and Jensen, 2008). The inlet air to the drum was controlled at 50 % RH and HEPA-filtered to ensure no particle background.

In the applied set-up, respirable dust is collected by a GK2.69 respirable dust sampler at 4.2 lpm (BGI, UK) and dust particle size-distributions are measured using the Fast Mobility Particle Sizer (FMPS 3091, TSI), with a range of 5.6 to 560 nm, and the Aerodynamic Particle Sizer (APS 3321, TSI) with a

range of 0.5 to 20 μm (Figure 2). It is important to note that these two instruments provide a size distribution which is expressed for the FMPS in electric mobility equivalent diameter, whereas for the APS, it is the equivalent aerodynamic diameter that is obtained. A GRIMM CPC may be connected for simultaneous number-concentration measurements, but not used in this study.



Figure 1 : Photograph showing the high-gloss polished inside of the dustiness drum. Also note the three lifter vanes marked a, b, and c at each 120° in the drum.

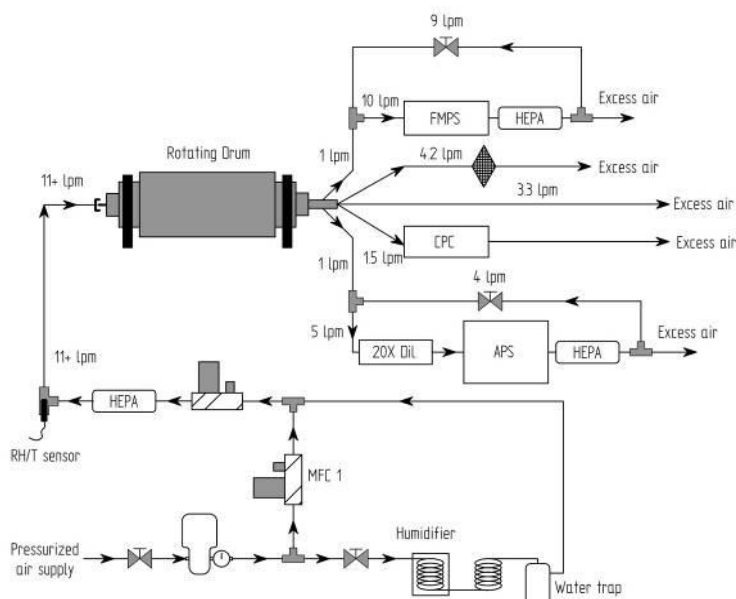

Figure 2 : Small rotating drum setup at NRCWE in the standard set-up for sampling respirable dust contemporaneously with online size-distribution analyses by FMPS, APS and number concentration by CPC.

The dustiness test was conducted in triplicates for each powder preceded by a so-called saturation run completed to coat all inner surfaces of the system with dust. The saturation test was performed using 2 grams of powder and rotation for 60 seconds. Then the actual triplicate tests were completed using 6 grams of test material per run. After each run the drum was emptied by pouring out the residual powder and gently tapping the drum three times with a rubber hammer. When loading the powder in the drum, it was carefully placed centrally in the drum on the upwards moving side of three inner lifter vanes placed at bottom position. Then the drum was sealed followed by 60 seconds

of background measurements were done to ensure a particle free test atmosphere. The experiment was then initiated by rotating the drum for 60 seconds during which particles were emitted and led through the airflow to the sampling train. After the drum was stopped, measurements and sampling was continued for additional 120 sec to catch the remaining airborne particles in the dust cloud. Thus, the total time during which the measurement is made is 180 s. This then completed the rotational test. The drum and sampling lines were thoroughly cleaned between each powder type using a HEPA-filter vacuum cleaner designed for asbestos cleaning and wet-wiping. Then the drum was let to air-dry before the next powder could be tested.

The mass of collected respirable dust was determined after conditioning the filters and controls in our weighing room (22°C; 50 %RH) using a Sartorius microbalance (Type R162 P; Sartorius GmbH, Göttingen, Germany). The mass is used to categorize the dustiness levels of the powders according to EN15051. Calculations of Dustiness Indexes, DI_{mass} , were done according to:

$$DI_{mass} = \frac{Q_{drum} \cdot m_{filter}}{Q_{cyclone} \cdot m_{drum}} \quad \text{Eq. 1}$$

where Q_{drum} and $Q_{cyclone}$ is the flows through the drum and cyclone respectively, m_{filter} is the blind-filter corrected filter mass in mg and m_{drum} is the powder mass loaded into the drum in kg.

In addition to the mass-based dustiness index, indexes for the total number of generated particles per mg of material during the 60 seconds of rotation and the 120 second directly follow were calculated as:

$$DI_{Number} = \frac{Q_{drum}}{m_{drum}} \cdot \sum_{t=0}^{180s} N_t^{cpc} \quad \text{Eq. 2}$$

where Q_{drum} is the flow through the drum in cm^3/s , m_{drum} is the powder mass loaded into the drum in mg and N^{cpc} is the CPC count in particles/ cm^3 . Number size distributions were calculated as the summed up numbers over the 180 sec as measured by FMPS and APS.

Rotating drum testing was made on all powders, except for the CNTs, because the test setup currently does not live up to our safety requirements for potentially highly toxic materials.

3.2 The Vortex Shaker (VS) method

The vortex shaker method (VS) consists of a centrifuge stainless tube agitated by a vortex in which the test powdered material is placed together with 100 μm diameter bronze beads. These are used to help the de-agglomeration of powders. HEPA filtered air, controlled at 50% RH, pass through the tube in order to transfer the released aerosol to the sampling and measurement section. The protocol developed for the experiments performed within this project used two different versions of the sampling and measurement section.

All tests were conducted with VS method using approximately 0.5 ml powder, which is placed in the sample vial together with 5 g bronze beads (100 μm), used to agitate and de-agglomerate the powder. The sample is allowed conditioning in the 50% RH before the shaker for a powder agitation period of 3600 s (60 min).

The first version (Figure 2) is devoted for real-time measurement using ELPI™ Classic (10 Lpm, Dekati) for size distributions according to the equivalent aerodynamic diameter and CPC (Model 3786 UWPCP, TSI) for number concentrations. This version is also devoted for collecting airborne particles for subsequent electron microscopy (EM) observations (see Figure 8). For each nanomaterials sample, test with this setup have been performed three times.

The results of the tests performed with this first version of the VS method leads to the determination of:

- Dustiness indices expressed as the total number of particles emitted (based on data from CPC) ;
- Particle size-distribution of the aerosol (based on data from ELPI™ Classic in its standard configuration).

The CPC used was the Model 3785 Water-based Condensation Particle Counter (TSI, USA). This CPC detects particles from 5 to >3000 nm. It provides a wide, dynamic, particle-concentration range, an essential characteristic for the tests considered. Featuring a single-particle-counting mode with continuous, live-time coincidence correction and a photometric mode, the CPC measures particle number concentrations up to 10^7 particles/cm³ with high accuracy.

ELPI™ (Electrical Low Pressure Impactor) is an instrument to measure airborne particle size distribution and concentration in real-time. It operates in the size range of 7 nm – 10 µm in its standard configuration. Because of its wide particle size range and rapid response (< 5 s), the ELPI™ has been considered an ideal measurement instrument for the analysis of the unstable concentrations and size distributions, or the evolution of size distributions that could be observed in these tests. In order to prevent particle bounce and charge transfer during the tests, all collection substrates used (PVC GELMAN GLA-5000 5µm / 25 mm) have been greased.

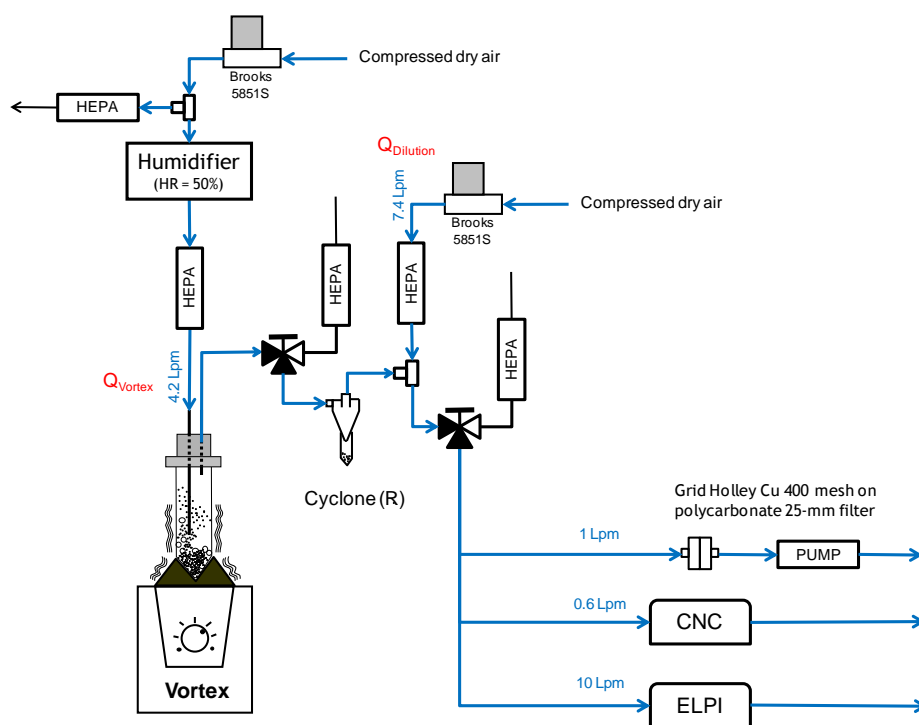

Figure 3 : Experimental set-up of the vortex shaker method for measuring number concentrations and particle-size distributions, and for collecting airborne particles for subsequent EM observations.

In the ELPI the measured current signals are converted to (aerodynamic) size distribution using particle size dependent relations describing the properties of the charger, the impactor stages, and the effective density of the particles. The particle effective density provides a relationship between

mobility and aerodynamics sizes. Effective density is a parameter which is complex to measure (Olferta *et al.*, 2007), and values for samples used in the project are not available in the literature. Therefore, the following assumption has been made for the data from the ELPI: spherical particle with a density equal to the density of the condensed phase of the material constituting the MN. Densities used were: 3.84 g/cm³ for NM100, 101, 102 and 4.26 g/cm³ for NM103, 104, 105 based on Teleki *et al.* (2008); 2.2 g/cm³ for all NM20x; 1.75 g/cm³ for all NM40x based on Kim *et al.* (2009). If this assumption is questionable, there is no robust method that can be applied to polydispersed aerosols over a wide size range, such as those used in the project. However, to assess the effect of this parameter on the results, the number size distributions were also calculated for a density of 1 g/cm³.

The total number of generated particles from the Vortex tube, $S_{Vortex}^{Number(CNC)}$, was calculated as:

$$S_{Vortex}^{Number(CNC)} = [Q_{Vortex} + Q_{Dilution}] \cdot \Delta t \cdot \sum_{i=0}^{T/\Delta t} C_{CNC}(t_0 + i \cdot \Delta t) \quad (-) \quad Eq. 3$$

Where:

- **T** is the time over which the total number of particles is calculated. This time is between 5 and 3600 s, the latter is the test duration in the original protocol of the VS method.
- Δt is the step time of the CNC (for all tests it was set as 5 s)
- $C_{CNC}(t_0 + i \cdot \Delta t)$ is the number concentration measured during the i th time interval
- Q_{Vortex} is the total air flow rate passing through the vortex tube (4.2 lpm)
- $Q_{Dilution}$ is the flow rate of dilution air (7.4 lpm).

The dustiness index in number of particles per gram, $DI_{Number(CNC)}$, was calculated as the total number of generated particles divided by the total mass of the test MN sample in milligrams:

$$DI_{Number(CNC)} = S_{Vortex}^{Number(CNC)} / m_{NM} \quad (1/mg) \quad Eq. 4$$

To get information on particle morphology of the emitted aerosol, a simple but specific sampling set-up has been designed (see Figure 8). Transmission electron microscope (TEM) copper grids were taped onto 25 mm diameter polycarbonate membrane filters (0.4 or 0.8µm). Fiber backing filters were used to support the polycarbonate filters. Air flow was driven by a personal sampling pump at a flow rate of 1 L/min. The duration of the sampling has been set to 1 hour. The sampling period was set equal to the duration of a test (1 hour). For some test, the sample was accumulated over two trials in order to have enough particles to observe. Different TEM copper grids having different carbon have been used (Carbon film, Quantifoil Holey Carbon Films or Holey Carbon Support Film).

It is important to note that the duration of the test is to be considered as the process is dynamic. In the original INRS protocol developed, the duration of a test was set equal to 3600 s. But in the first version of the set-up (cf. Figure 3), as the instruments measure in real time, it is possible to perform

the calculation for different durations between 0 and 3600 s. In this report, the calculations based on the CNC data were performed for two durations: 180 s and 3600 s. The first duration (180 s) was chosen to be consistent with the method SD. For the second version of the setup, the duration of the test was set to 3600 s, which corresponds to the original protocol of the Vs method.

The second version of the setup (Figure 4) is used for collecting respirable mass fraction of the emitted aerosol. The respirable mass fraction is obtained by sampling with a GK2.69 cyclone (BGI, UK). The filters have been pre-weighed and post-weighed following the recommendations of the ISO 15767:2009 on the same analytical balance. Only one test was performed with this setup due to time constraints. This is why the results are not presented with a confidence interval based on reproducibility. However, measurement uncertainty has been calculated for each measurement performed.

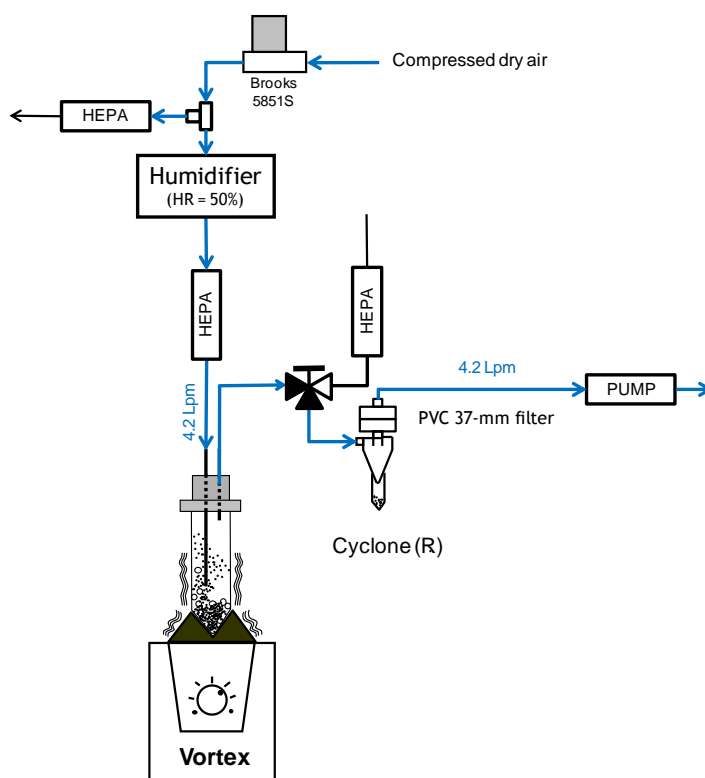

Figure 4 : Experimental set-up of the vortex shaker method for collecting respirable mass fraction of the emitted aerosol.

The dustiness index in respirable mass (mg) of particles per kilogram, $DI_{Mass (GK2.69)}$, was calculated as the respirable mass of generated particles in milligrams divided by the total mass of the test MN sample in kilograms:

$$DI_{Mass (GK2.69)} = S_{Vortex}^{Mass (GK2.69)} / m_{NM} \quad (\text{mg/kg}) \quad \text{Eq. 5}$$

The recommendations of the standard ISO 15767:2009 were followed to determine the LOD of the weighing procedure for the filters used for sampling respirable mass of particles during this project.

The LOD for the PVC GELMAN GLA-5000 (5 µm/37 mm) filters was equal to 20 ng. This value is used to determine the LOD expressed in dustiness index.

The figure below shows the flow diagram of the experimental protocol used for the NGT project.

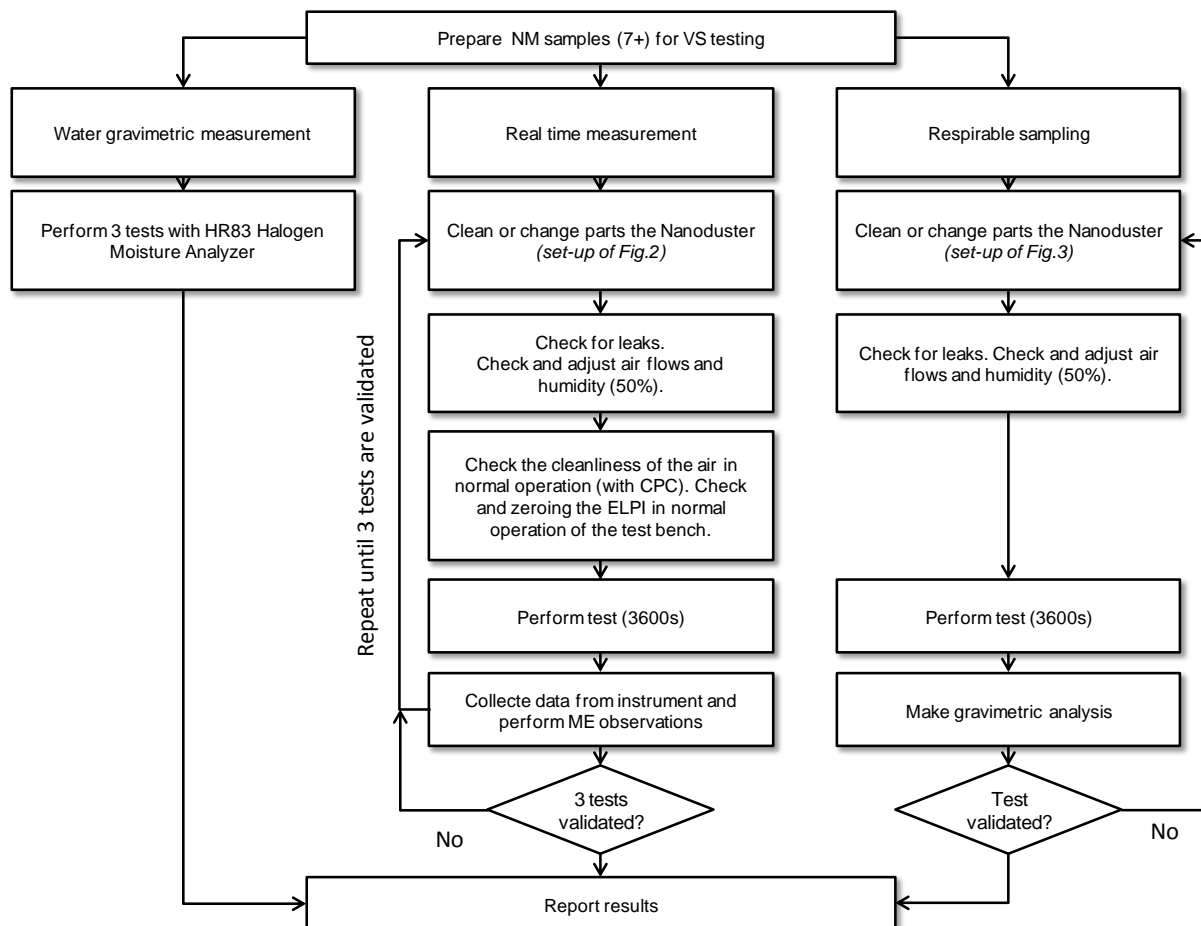

Figure 5: Flow diagram describing the different stages of the cycle of a test conducted according to the VS method for a powder sample MN.

The preparation of MN samples for VS testing include: 1) to take a series of 7 samples of 0.5 cm³ of the vial containing the nanomaterial received at the laboratory in this project, 2) to accurately weigh the samples. Three of the samples are devoted for test with the first version of the set-up (real-time measurement, see Figure 3), one for the second version (respirable mass fraction measurement, see Figure 4) and three for the gravimetric water content measurement.

Any additional samples are intended to further testing that would be needed in case of default validation. Microcentrifuge graduated tubes with secure seals and caps have been chosen to keep the 0.5 cm³ samples.

The gravimetric water content was performed using a HR83 Halogen Moisture Analyzer (Mettler Toledo) and following a drying program defined specifically for small quantities of used MN (Temperature = 160°C; duration = 170 s).

The weighing of the MN samples was performed with a XP205 analytical balance (10 µg readability, Mettler Toledo) while the weighing of the 37-mm filters from the respirable sampler was performed with a MX5 microbalance (1 µg readability, Mettler Toledo).



Figure 6: Microcentrifuge tube filled with a MN sample of 0.5 cm³ for a dustiness test according to the VS method.

Particular attention was given to the experimental device cleaning between successive tests. All pipes and other connections were systematically cleaned with water and/or ethanol and dried in an oven, or eventually changed. The checking of the airflows was performed using a primary flow bubble calibrator (Gillian® Gillibrator 2). Prior to each test, the cleanliness of the air was assessed on the basis of measurements made using the CNC. In the case of a non-compliant result, everything was taken from the beginning.

The validation of a test depends on several factors such as: 1) the stability of the parameters during the test, 2) a good reproducibility of measured number concentrations, 3) a good sequence of steps for the respirable aerosol sampling etc.

The entire set-up was located inside a variable volume fume hood to prevent exposure of the operator (see Figure 7 and Figure 8). Similarly, all operations like weighing, water content measurement and sample preparation were carried out in a specific containment system that has a unique turbulent-free, low flow design which allows our sensitive balance to operate without fluctuation and protects the operator from exposure to airborne particles that could be released when handling and weighing MN samples (see Figure 9).

When it comes to perform dustiness tests with carbon nanotubes samples, it was decided that the operator wears a respirator mask as shown on the Figure 10 to further limit potential exposure.



Figure 7 : Overview of the vortex shaker set-up positioned in the variable flow fume hood at INRS.

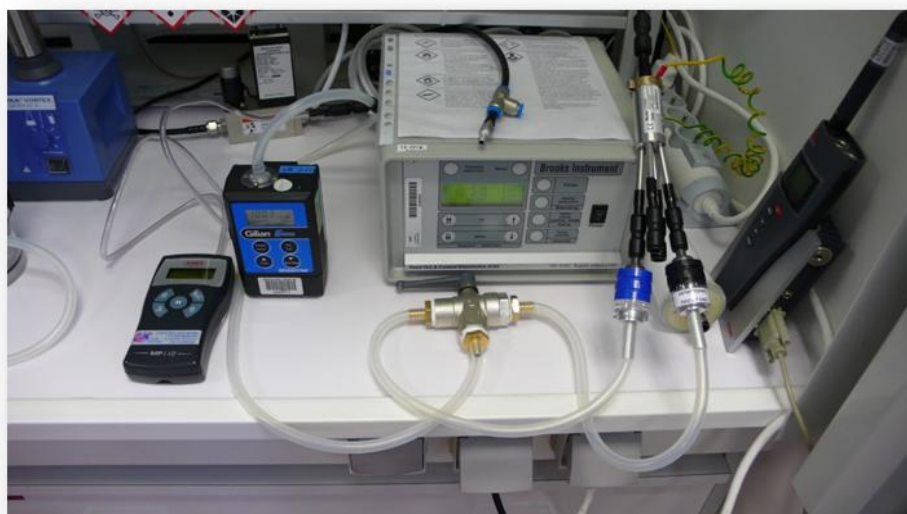

Figure 8 : View of the set-up designed to collect emitted particles on grids for EM observations.



Figure 9 : Operator during MN sample preparation (weighing and water content measurement) in the powder handling enclosure at INRS.



Figure 10: Operator introducing a MN sample into the Vortex Shaker positioned in the variable volume fume hood used at INRS.

4 Results

4.1 Small rotating drum (SD) method

All experimental data obtained with the SD method are summarized in Table 4.

Table 4 : Number of dust particles and mass-based dustiness indexes of TiO₂ nanomaterials (NM10x) and SAS (NM20x) nanomaterials. Experimental data with the SD method are obtained over a test time of 180 s as explained in the chapter 2.1.

Sample	Test mass (g)	Number (1/mg) CPC	Dustiness index	
			Inhalable	Mass (mg/kg) Respirable
NM-100	-	-	-	-
NM-101	6	1.10E+06	728 (±10)	24 (±9)
NM-102	2	2.96E+05	268 (±39)	15 (±2)
NM-103	6	1.80E+07	9185 (±234)	323 (±166)
NM-104	6	4.13E+05	3911 (±235)	38 (±7)
NM-105	6	3.16E+05	1020 (±20)	28 (±10)
NM-200	4	6.16E+06	6459 (±273)	293 (±193)
NM-201	4	5.82E+06	6034 (±199)	218 (±24)
NM-202	4	4.13E+06	4988 (±1866)	91 (±11)
NM-203	1.5	6.30E+06	5800 (±1488)	354 (±6)
NM-204	2	8.25E+06	24969 (±601)	1058 (-)

Figure 11 shows the particle number size distributions of aerosols generated during rotating drum dustiness testing of the TiO₂ samples. It is evident that all TiO₂ powders appear to generate fine aerosol with an electrical mobility equivalent peak diameter typically between 200 and 250 nm. Larger μm-size-modes are present all in samples. One sample, NM-102, was very dusty and generated slightly higher concentrations of μm-size dust particles than sub-μm size dust particles. This is an unusual particle size-distribution profile.

Figure 12 shows the particle number size distributions of aerosols generated during rotating drum dustiness testing of the SAS MN samples. The SAS powders generate fine aerosol with an electrical mobility equivalent peak diameter typically between 200 and 300 nm. Larger μm-size-modes are present in all samples, but none of the coarse mode particle concentrations exceed the 200-300 nm mode-size particle concentrations. NM-203 produces the lowest number of particles, but also generates the finest dust particles measured by FMPS as seen by smallest peak sizes and a shoulder mode around 60 nm.

Figure 13 and Figure 14 shows respectively the dustiness ranking of inhalable and respirable dust for TiO₂ nanomaterials (NM10x) and SAS (NM20x). Compared to conventional mass-based dustiness indexing of the EN 15051 standard, the TiO₂ nanomaterials vary from low to high dustiness in both size fractions. There also seems to be good agreement between the respirable and inhalable dustiness indexing. Concerning the SAS nanomaterials, the index are only categorized with high dustiness indices. However, there appears to be a larger variation in respirable dustiness ranking than for inhalable dust where NM-204 is observed to have very high dustiness levels.

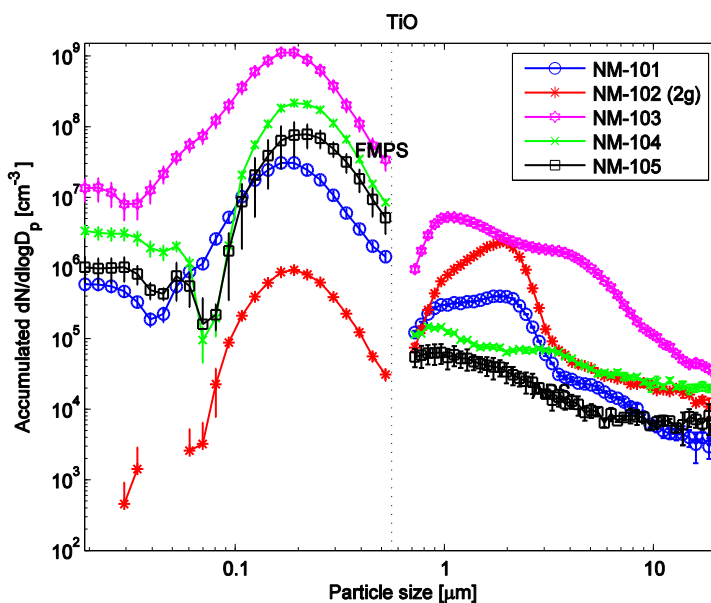

Figure 11 : Particle number size distributions for TiO₂ MN obtained with the SD method. All distributions are presented as given by the FMPS (electrical mobility equivalent diameter) and APS (aerodynamic equivalent diameter).

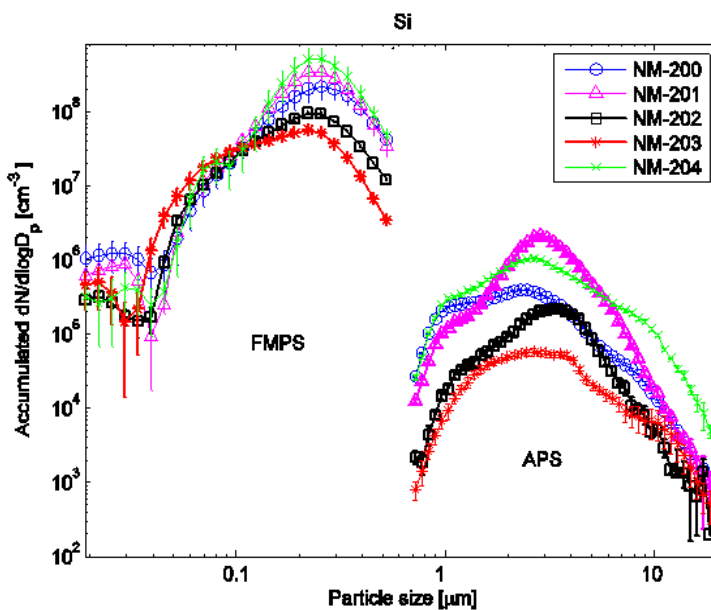

Figure 12 : Particle number size distributions for SAS MN. All distributions are presented as given by the FMPS (electrical mobility equivalent diameter) and APS (aerodynamic equivalent diameter).

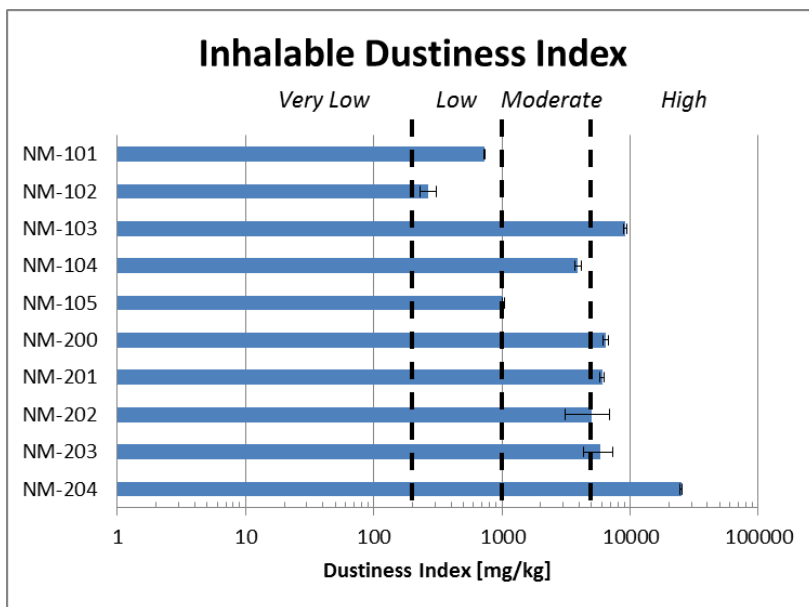

Figure 13: Dustiness ranking of inhalable dust for TiO₂ nanomaterials (NM10x) and SAS (NM20x) nanomaterials as obtained with the small rotating drum method at NRCWE.

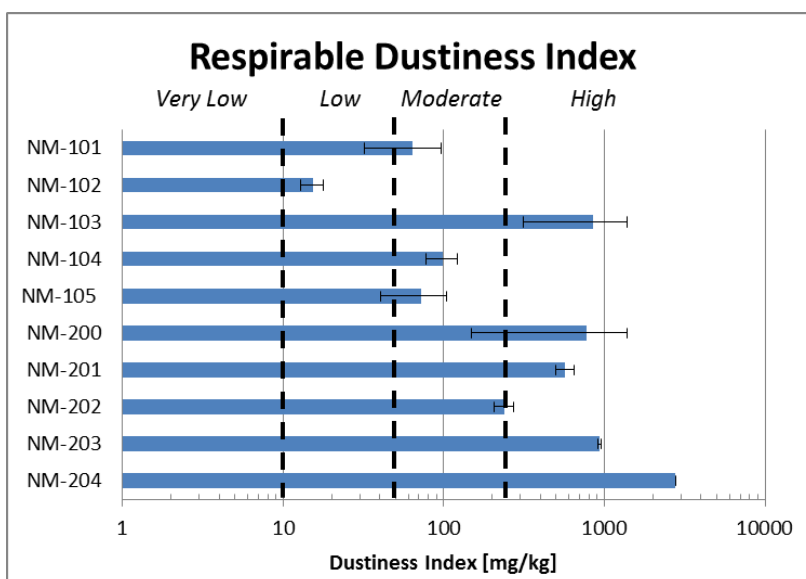

Figure 14 : Dustiness ranking of respirable dust for TiO₂ nanomaterials (NM10x) and SAS (NM20x) nanomaterials as obtained with the small rotating drum method at NRCWE.

4.2 Vortex Shaker (VS) method

The following table provides information on the gravimetric water content (expressed in terms of the mass of water per unit mass of the dried sample in percentage) and bulk density of the nanomaterials in powders. The results were obtained in tests conducted in the INRS laboratory. Only TiO₂ and SiO₂ samples were treated. The water content was not determined for NTC samples as the conditions for the manipulation were not satisfactory, especially in terms of prevention of operator exposure.

Table 5: Gravimetric water content and bulk density of the TiO₂ and SiO₂ samples.

Sample	Sample mass (mg)	Water content (wt % dry)	Bulk density (g/cm ³)
NM-100	135	1%	0.69
NM-101	110	10%	0.41
NM-102	120	3%	0.31
NM-103	126	2%	0.44
NM-104	108	3%	0.33
NM-105	112	1%	0.10
NM-200	121	8%	0.12
NM-201	195	8%	0.28
NM-202	147	1%	0.13
NM-203	119	1%	0.03
NM-204	134	6%	0.16
NM-400	Not measured		0.08
NM-401			0.02
NM-402			0.11
NM-403			0.17

Experimental data obtained with the Vs method are summarized in the

Table 6 below. Number-based data with the VS method are calculated from the time profiles with two test times (see page 12): 180 s and 3600 s. The first duration (180 s) was chosen to correspond to the test duration of the SD method. The mass-based data correspond to the respirable fraction only as the inhalable fraction was not part of the VS original protocol. The duration for the mass-based data is 3600 s.

As an example, Figure 15 below shows the time profiles of number particle concentration as measured by the CPC for SAS NM 204. This figure illustrates the repeatability obtained for identical tests with the VS method. In this example, it can be observed that after the peak concentration (here it takes about 150 s), the number concentration stabilizes and declines only slightly over the duration of the test. Each MN tested shows a temporal profile which can be quite different.

Table 6: Number-based and mass-based dustiness indexes of TiO₂ nanomaterials (NM10x), SAS (NM20x) nanomaterials and NM40x carbone nanotubes nanomaterials.

Sample	Test mass (mg)	Dustiness index						Mass (mg/kg)	
		Number (1/g)				T = 3600 s		Respirable (s.D) ^c	
		T = 180 s		T = 3600 s		CPC (s.D) ^b			
		CPC (s.D) ^b	ELPI ^a (s.D) ^b	ELPI ^a (s.D) ^b	ELPI ^a (s.D) ^b	CPC (s.D) ^b	CPC (s.D) ^b		
NM-100	341.7	1.2E+05 (2.7E+04)	1.0E+05 (2.2E+04)	1.0E+05 (2.2E+04)	8.3E+05 (3.4E+05)	8.3E+05 (3.4E+05)	1.5E+03 (1.33E-03)		
NM-101	206.6	1.6E+05 (2.1E+04)	3.2E+05 (7.0E+04)	3.2E+05 (7.0E+04)	3.1E+06 (3.5E+05)	3.1E+06 (3.5E+05)	5.6E+03 (5.00E-03)		
NM-102	153.7	9.6E+04 (9.3E+03)	9.6E+04 (8.5E+04)	9.6E+04 (8.5E+04)	7.0E+05 (2.8E+04)	7.0E+05 (2.8E+04)	9.2E+03 (8.25E-03)		
NM-103	216.8	5.4E+05 (8.0E+04)	2.0E+06 (2.7E+05)	2.0E+06 (2.7E+05)	1.9E+06 (1.7E+05)	1.9E+06 (1.7E+05)	1.9E+04 (1.70E-02)		
NM-104	165.6	4.3E+04 (3.6E+03)	2.5E+05 (2.8E+05)	2.5E+05 (2.8E+05)	2.1E+05 (2.8E+04)	2.1E+05 (2.8E+04)	6.4E+03 (5.67E-03)		
NM-105	50.3	3.5E+04 (1.3E+04)	9.9E+05 (1.1E+06)	9.9E+05 (1.1E+06)	2.3E+05 (2.7E+05)	2.3E+05 (2.7E+05)	1.1E+04 (9.66E-03)		
NM-200	60.2	2.9E+06 (2.9E+05)	1.1E+07 (6.0E+06)	1.1E+07 (6.0E+06)	8.2E+06 (1.3E+06)	8.2E+06 (1.3E+06)	3.4E+04 (3.04E-02)		
NM-201	140.0	4.6E+04 (1.3E+04)	9.3E+04 (4.2E+04)	9.3E+04 (4.2E+04)	8.6E+05 (1.1E+05)	8.6E+05 (1.1E+05)	6.5E+03 (5.81E-03)		
NM-202	62.6	5.6E+04 (1.3E+04)	2.1E+05 (2.0E+04)	2.1E+05 (2.0E+04)	1.6E+06 (9.9E+05)	1.6E+06 (9.9E+05)	1.7E+04 (1.54E-02)		
NM-203	14.3	4.1E+05 (1.1E+04)	1.6E+06 (2.0E+05)	1.6E+06 (2.0E+05)	2.1E+07 (1.1E+07)	2.1E+07 (1.1E+07)	5.1E+04 (4.55E-02)		
NM-204	79.4	1.3E+06 (1.5E+05)	2.6E+06 (3.9E+05)	2.6E+06 (3.9E+05)	3.0E+06 (5.2E+05)	3.0E+06 (5.2E+05)	1.4E+04 (1.22E-02)		
NM-400	36.6	1.5E+05 (5.7E+04)	1.9E+05 (1.8E+05)	1.9E+05 (1.8E+05)	5.3E+05 (2.0E+05)	5.3E+05 (2.0E+05)	< 4.2E+02 ^d		
NM-401	8.8	4.0E+06 (2.2E+06)	5.2E+06 (3.2E+06)	5.2E+06 (3.2E+06)	6.8E+06 (4.7E+06)	6.8E+06 (4.7E+06)	< 1.7E+03 ^d		
NM-402	59.6	1.0E+05 (8.9E+03)	1.0E+05 (6.1E+04)	1.0E+05 (6.1E+04)	6.6E+05 (2.1E+04)	6.6E+05 (2.1E+04)	4.2E+03 (3.75E-03)		
NM-403	86.1	3.9E+04 (1.2E+04)	< LOD	< LOD	3.5E+05 (3.4E+04)	3.5E+05 (3.4E+04)	4.9E+03 (4.39E-03)		

^a The assumption for calculating the number of particles emitted from the data from the ELPI is: spherical particle with a density equal to the density of the condensed phase of the material constituting the NM. Densities used were: 3.84 g/cm³ for NM100, 101, 102 and 4.26 g/cm³ for NM103, 104, 105 based on Teleki *et al.* (2008); 2.2 g/cm³ for all NM20x; 1.75 g/cm³ for all NM40x based on Kim *et al.* (2009).

^b standard deviation calculated over 3 repeats

^c measurement uncertainty as there was no repeat for this tests

^d correspond to the LOD in mass dustiness index

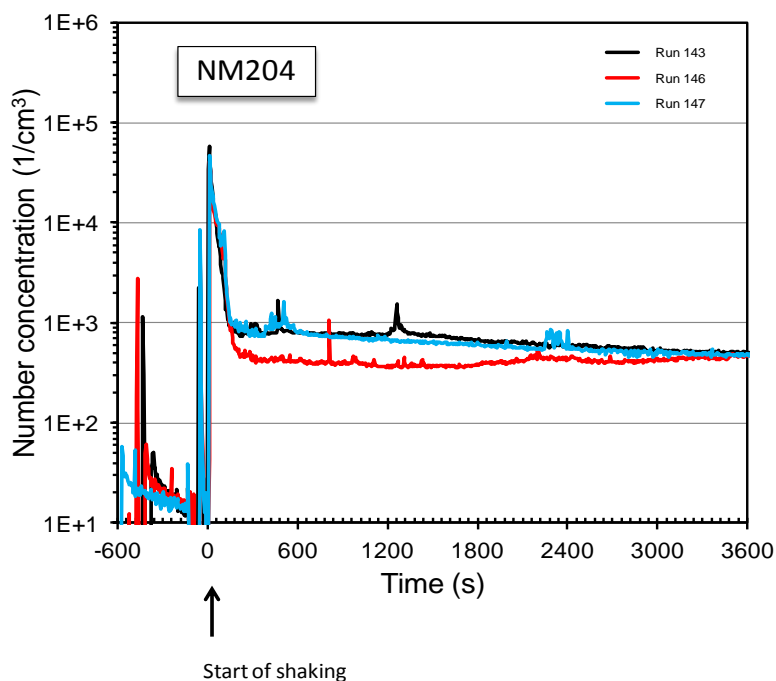

Figure 15 : Time profiles of number particle concentration as measured by the CPC for SAS NM 204. Each profile correspond to a different test.

The Figure 16 below shows the respirable mass-based indices of all MN tested with the VS method. There is a wide variation in the indices of all MN. The highest values were obtained with the SAS NM 203 ($5.1E+04$ mg/kg) while the lowest with the NTC NM400 ($< 4.2E+02$ mg/kg). In both categories TiO_2 and SiO_2 , the MN samples show behavior quite distinct. As observed for the SD method, the TiO_2 samples show indices lower than the SiO_2 samples. It is difficult to say something about the NTC because for two of them (NM400 and 401) the indexes were not significant, below the limits of detection (LODs). However, both NTC samples NM402 and 403 shows indices quasi-equivalent, well above the LODs.

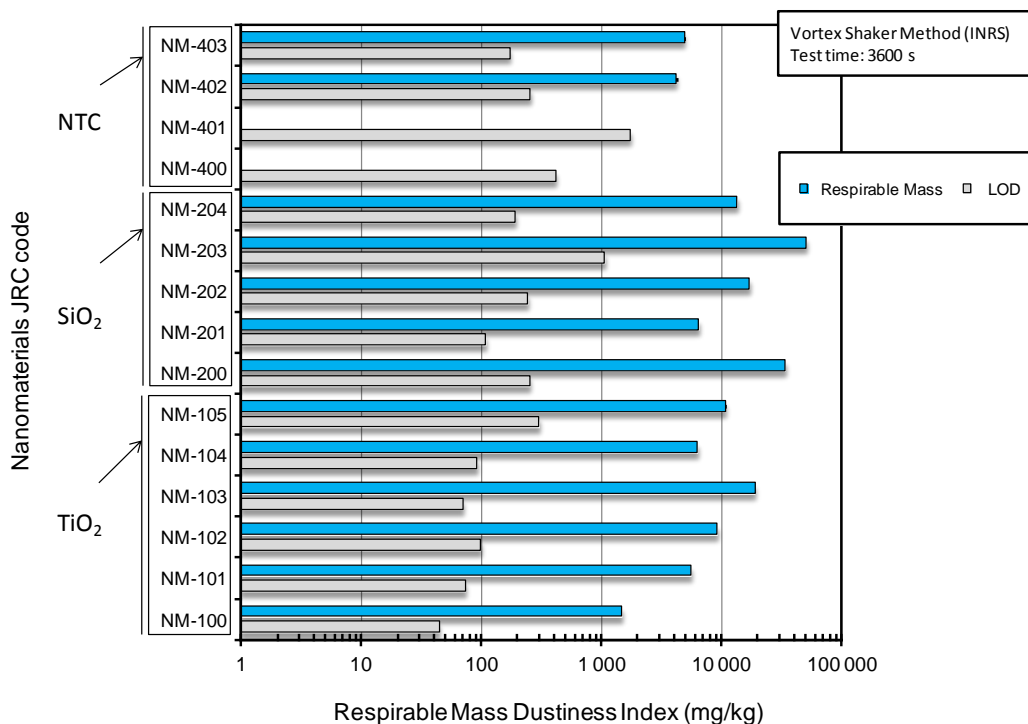

Figure 16 : Respirable mass dustiness indices of MN tested with the VS method. The gray bars correspond to the LOD expressed in mass-based indices. Respirable mass dustiness indices are presented with their measurement uncertainty but not visible on the graph as below 1%.

Figure 17 shows the number (1/mg) and respirable mass (mg/kg) dustiness indices of MN tested with the VS method. The MN samples were classified according to their highest respirable mass index to the lowest. There is no correlation between the two presented indices, respirable mass or number. The ratio between the max and min values is similar for both number and respirable mass indices, it is ~100. For both NM 400 and 401, the respirable mass collected on the cyclone filter was below the LOD of the weighing procedure. It is interesting to note that, for both NM400 and 401, while the results in respirable mass are below the detection limit, the values obtained in number of particles emitted are significant.

In the following Figure 18 it can be observed the influence of test duration on the calculation of the number dustiness index (1/mg). The relationship between these two indices varies greatly from about a factor of 2 to over 50 (this is the case for the MN 203).

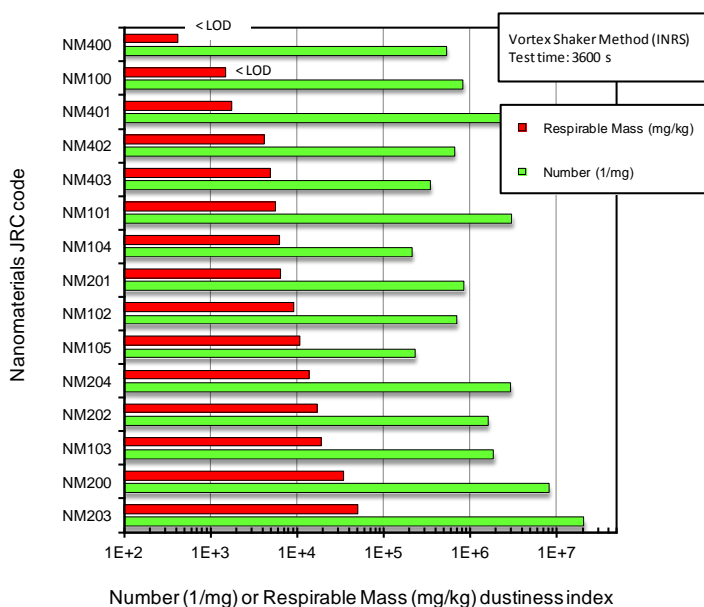

Figure 17: Number (1/mg) and respirable mass (mg/kg) dustiness indices of MN tested with the VS method.

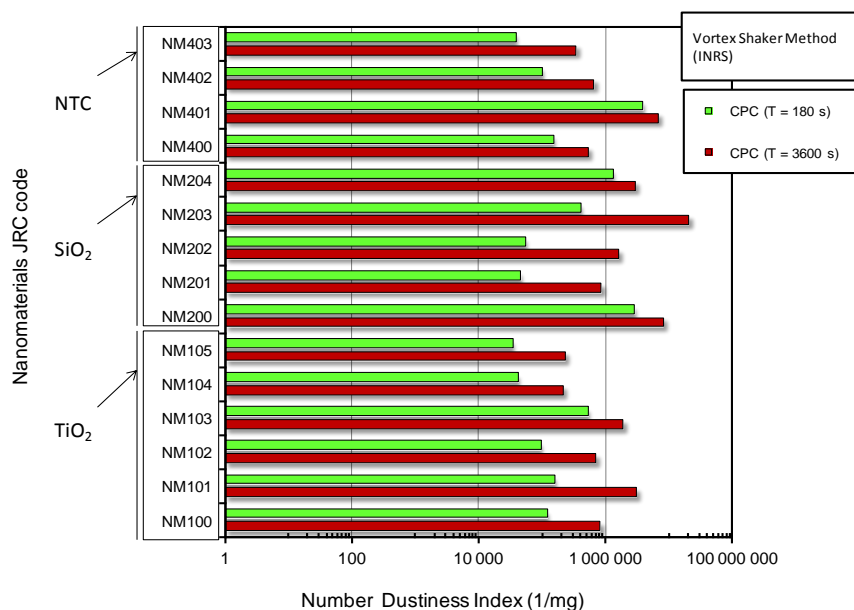

Figure 18 : Number (1/mg) dustiness indices for all MN tested with the VS method as measured by CPC. Comparison of two test times T for calculation: 180 and 3600 s.

Figures 19, 20 and 21 show the particle number size distributions for all MN samples obtained with the VS method and measured by the ELPI Classic (standard configuration). All distributions are presented as given by the ELPI (aerodynamic equivalent diameter). For each MN sample, the particle number size distribution is shown for two values of the particle density (see above in chapter 3.2). It

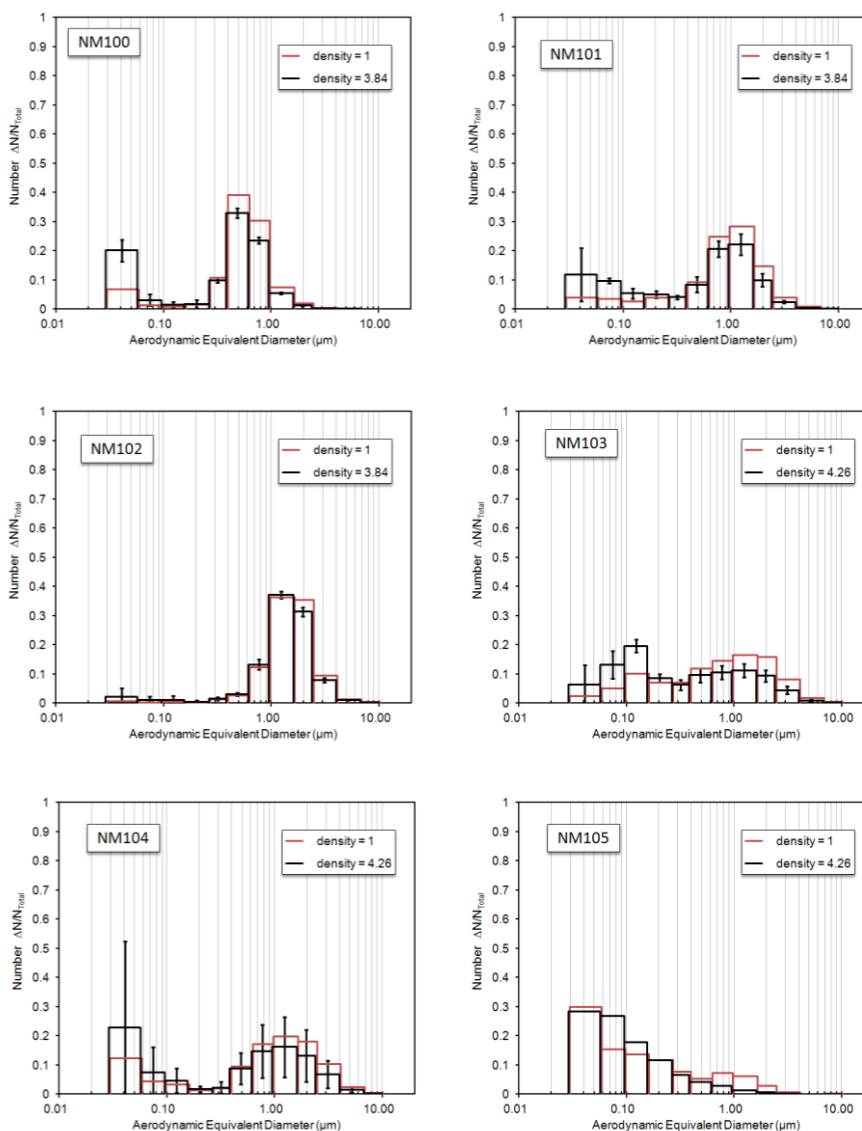

Figure 19: Particle number size distributions for TiO₂ MN samples obtained with the VS method and measured by the ELPI Classic (standard configuration). All distributions are presented as given by the ELPI (aerodynamic equivalent diameter). Densities used were: 3.84 g/cm³ for NM100, 101, 102 and 4.26 g/cm³ for NM103, 104, 105 based on Teleki et al. (2008).

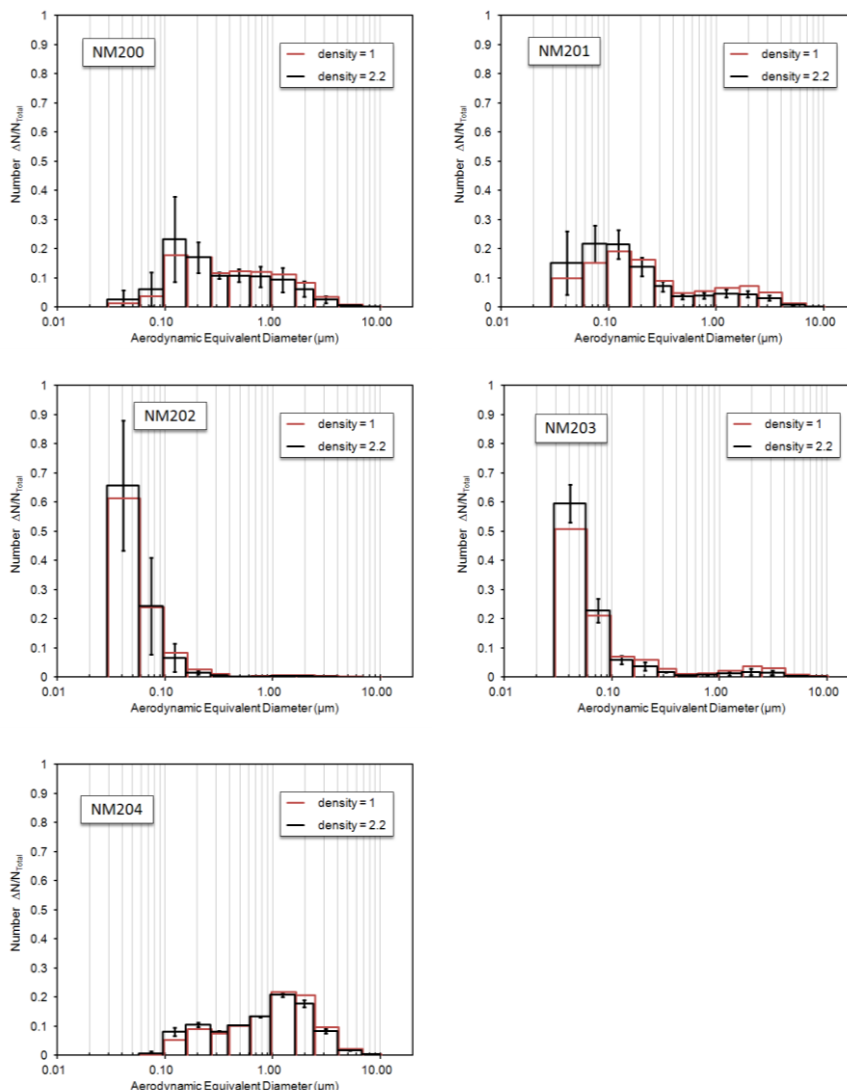

Figure 20 : Particle number size distributions for SiO₂ MN samples obtained with the VS method and measured by the ELPI Classic (standard configuration). All distributions are presented as given by the ELPI (aerodynamic equivalent diameter). Densities used were 2.2 g/cm³ for all NM20x.

should be noted that the representation chosen here is for the Y axis is the relative number ($\Delta N/N_{total}$), so that we can directly compare the size distributions between them. Of all the figures, there are distinct differences on the size distributions:

Concerning the TiO₂ MN samples, although it is difficult to compare these size distributions to those obtained with SD method (distinct method and aerosol instruments), there are some similarities. To mention only two:

- The size distributions appear bimodal with the exception of the NM105.
- The fraction of micrometer size particles is the most important for the NM 102

Two profiles appear to distinguish among SiO₂ MN samples:

- NM 202 and 203 with a very predominant proportion below about 500 nm.
- The others with a better balanced proportion between the micron and submicron fractions.

Here, the comparison with the data obtained by the method SD is more difficult.

For carbon nanotubes, the NM401 is clearly distinguishable from the others with an aerosol which is characterized by a mode around 300 nm. For other samples of carbon nanotubes, the measurements obtained using the ELPI are questionable because of the low number of particles emitted (near the background noise of the instrument). Consequently, the size-distributions presented here should be taken as being qualitative determinations.

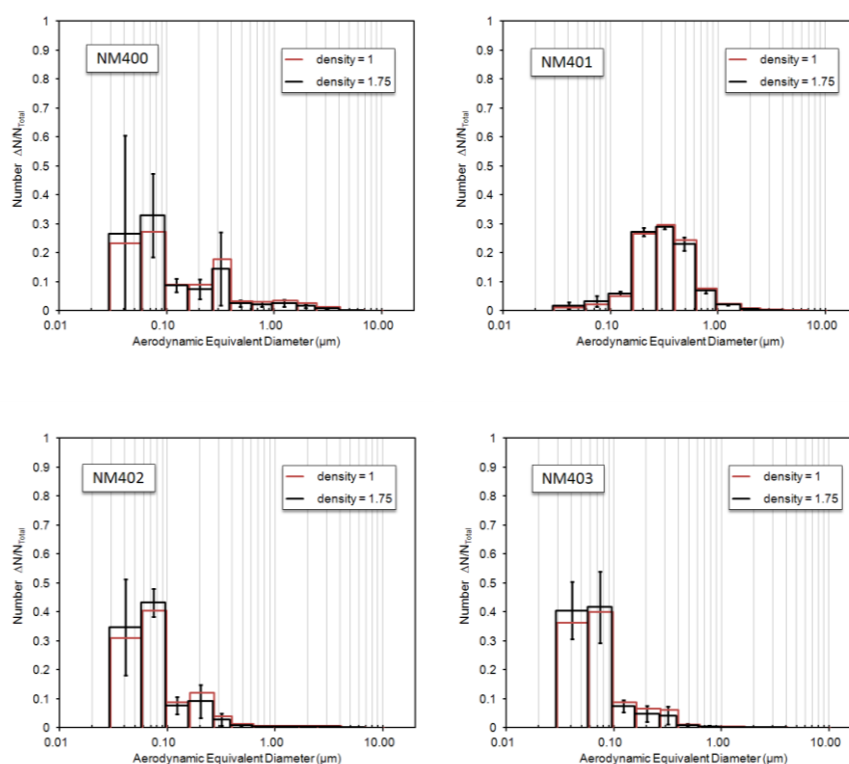

Figure 21 : Particle number size distributions for carbon nanotube MN samples obtained with the VS method and measured by the ELPI Classic (standard configuration). All distributions are presented as given by the ELPI (aerodynamic equivalent diameter). Densities used were 1.75 g/cm³ for all NM40x based on Kim et al. (2009).

Figure 22 ; Figure 23 ; and Figure 24 show TEM pictures of three of the representative MNs used in the project: NM 102, NM 204 and NM 401. The photographs qualitatively show the diversity of the particles observed on each grid. These photographs must not be considered for any quantitative analysis. The sampling duration is indicated on each of the figures. Concerning NM102 and NM204, the images show both agglomerates/aggregates of micrometer-sized particles as well as sub-micrometer-sized particles as given by the ELPI results. For NM401, the pictures show bundles of

carbon nanotubes as well as single fibers of micrometer-sized length. The observation of free tubes generated by dustiness testing is important information for the potential exposure associated with handling of CNT MN.

NM 102

TEM grid: 200 mesh with a carbon film

Sampling duration: 136 min

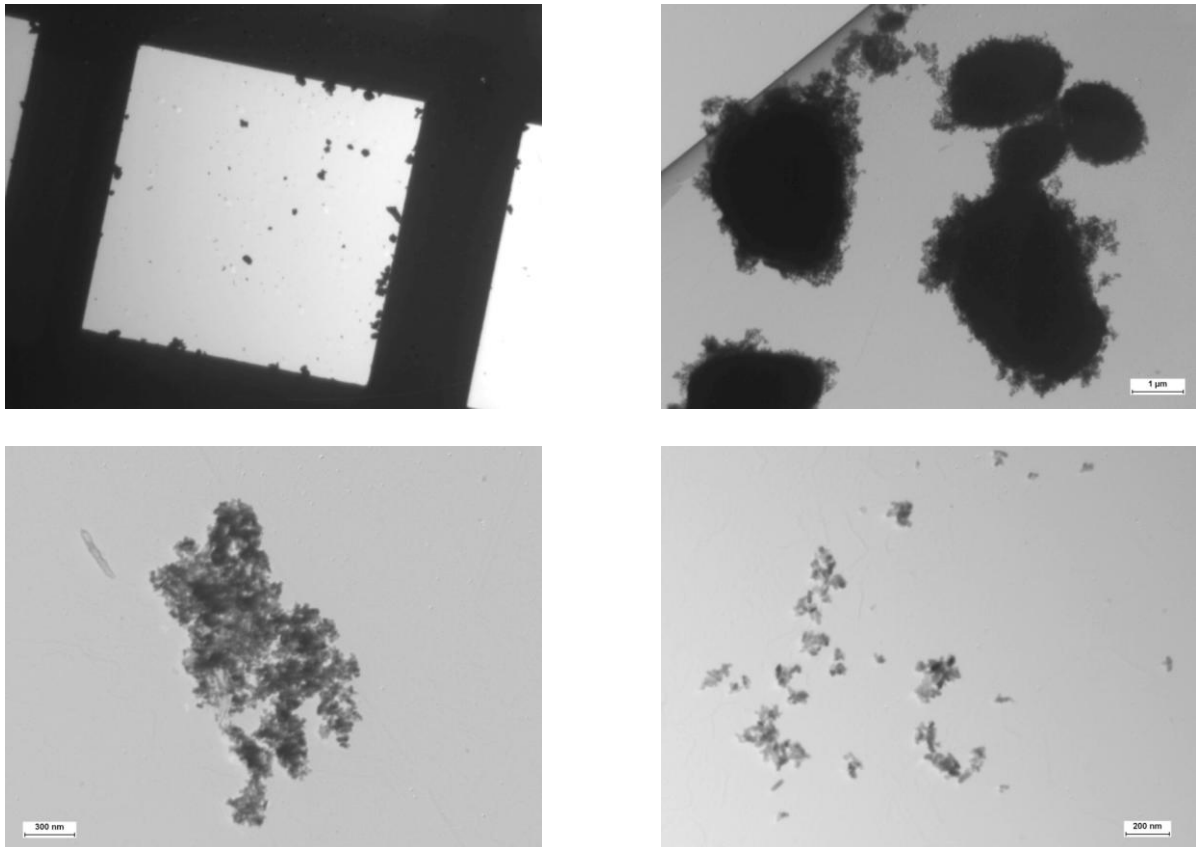

Figure 22 : Photography by transmission electron microscopy of the grid sampled with NM102

NM 204

TEM grid: QUANTIFOIL®– Holey Carbon Films

Sampling duration: 71 min

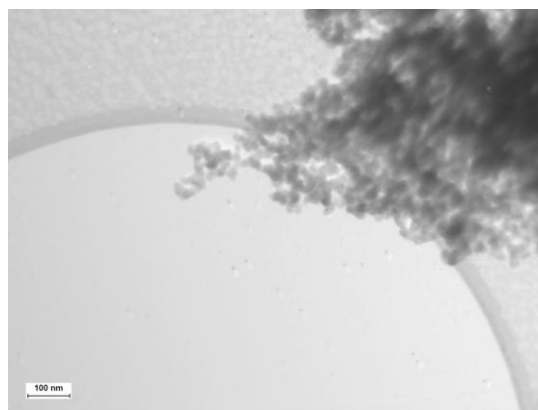
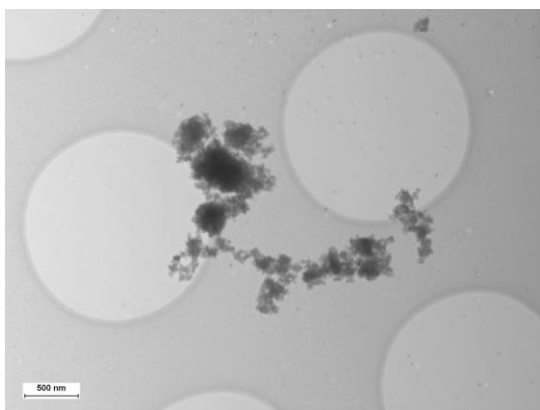
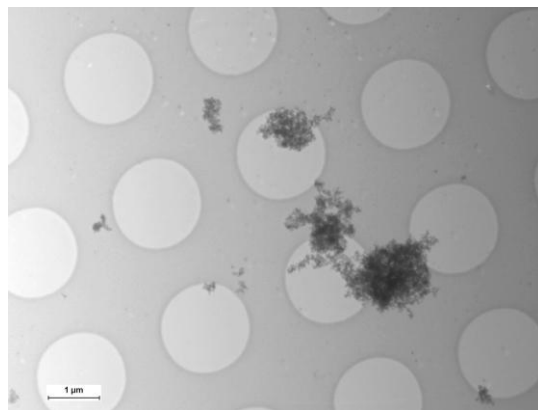
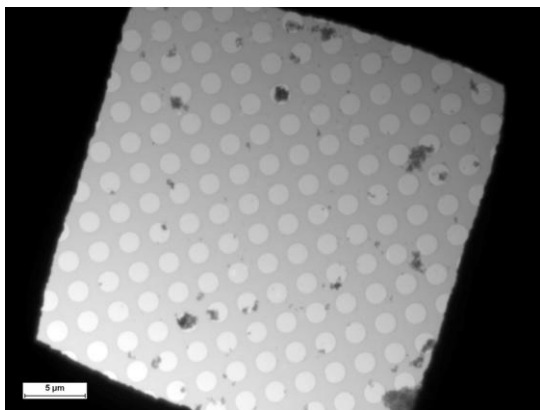

Figure 23 : Photography by transmission electron microscopy of the grid sampled with NM204.

NM 401

TEM grid: Holey Carbon Support Film
Sampling duration: 74 min

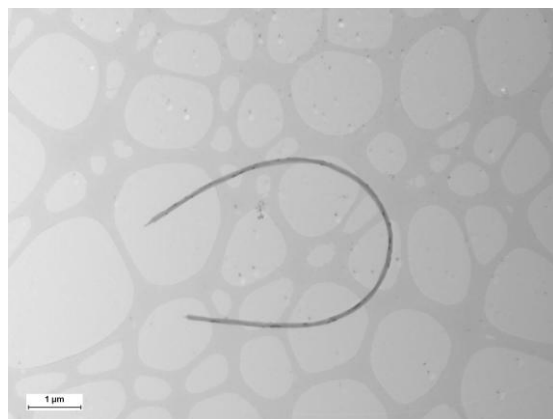
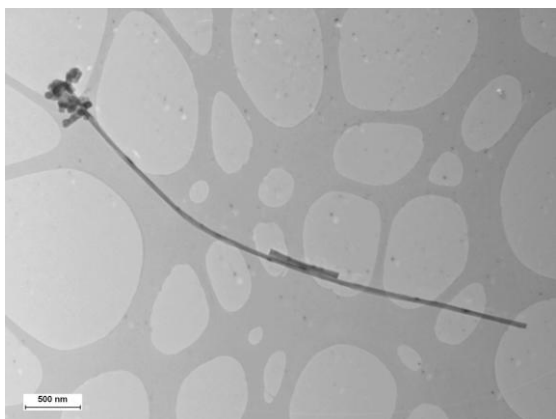
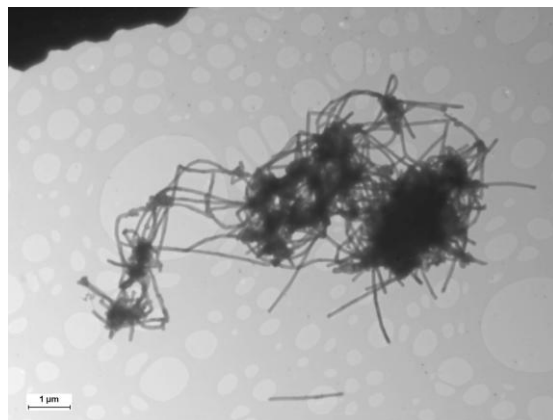
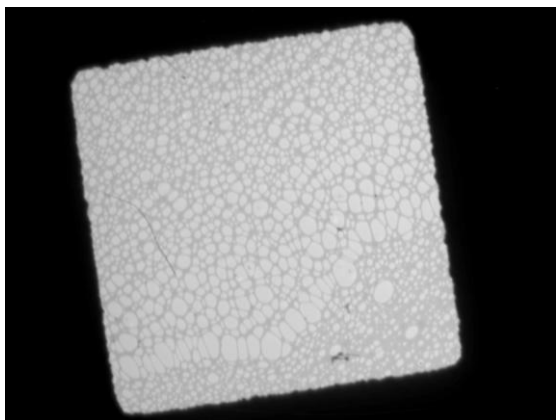

Figure 24: Photography by transmission electron microscopy of the grid sampled with M401

4.3 Comparison between SD and VS method

Figure 25 and Figure 26 compares the respirable mass dustiness indices obtained according to the two methods (SD and VS) used in the project. Figure 26 is identical to Figure 25 except that the data are presented here according to the respirable mass indices ranked from the highest to the lowest for the method VS. It can be seen that the two methods do not lead to the same classification according to this indices. There are several reasons to explain this but this beyond the scope and objective of this report. Regarding the fact that the VS method lead to higher respirable mass indices than the SD method, it is probably because the VS method is a method that transmit more energy to the MN powder sample than the SD method. However, it is not yet possible to quantify the energy input for both methods. Such issue needs to be investigated before standardized tests can be defined.

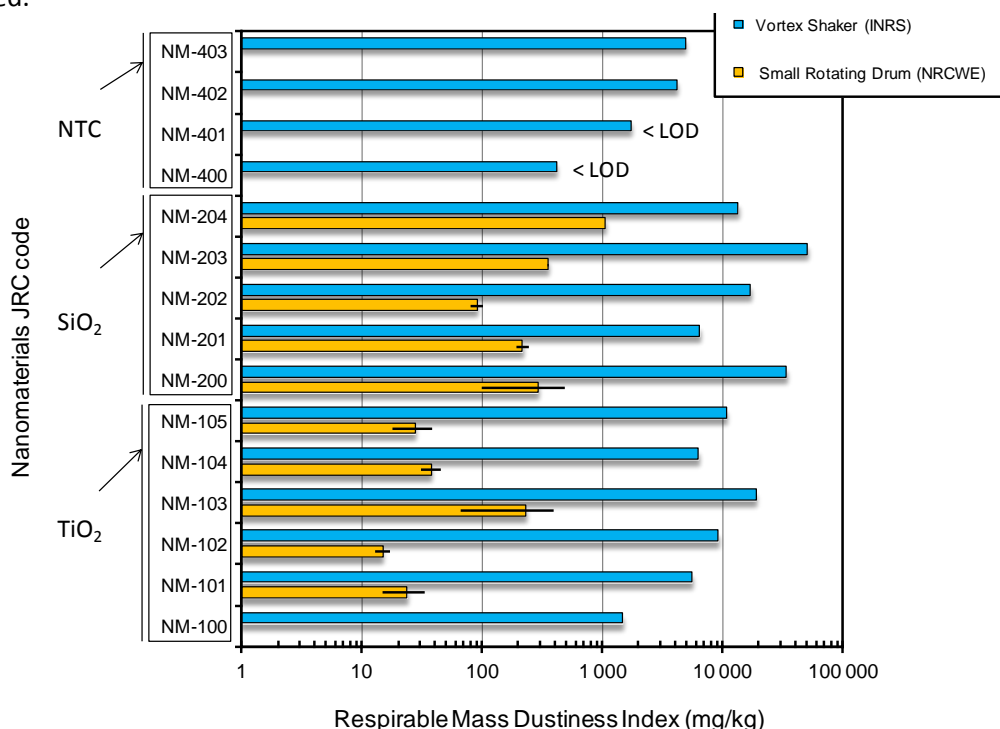

Figure 25 : Comparison between respirable mass dustiness indices obtained with the small rotating drum (SD) and vortex shaker (VS) method. Errors bars on the SD values correspond to the reproducibility over 3 repeats. The NM40x samples have been tested with the VS method only.

As written in the introduction, dustiness is not an intrinsic physical or chemical defined property of a powder, but its level depends on as well as characteristic properties of the powders and the activation energy in the simulated handling. Therefore different values may be obtained by different test methods (test apparatus, operation procedure, sampling and measurement strategy, etc.). It seems obvious that the absence of a harmonized approach concerning the measurement strategies and techniques, metrics and size ranges and the procedures of data analysis and reporting severely limits the comparison of these dustiness methods. Very little work has been done so far in this direction. That is why such a harmonized approach has been already integrated into various

European research programs to be launched soon. One of them will be realized within the framework of the Mandate 461.

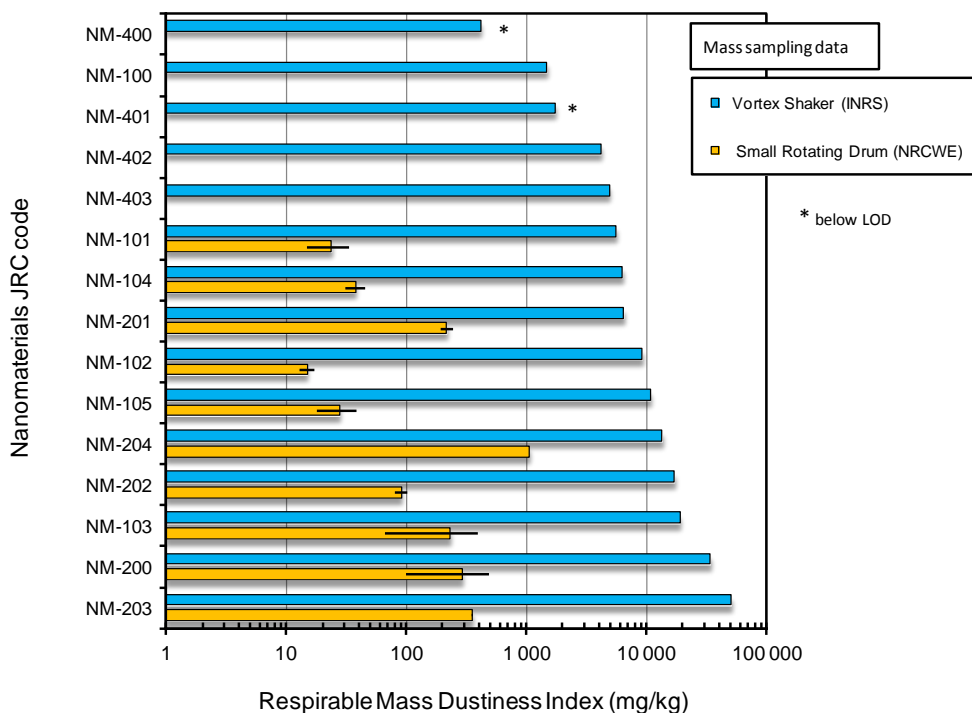

Figure 26 : Comparison between respirable mass dustiness indices obtained with the small rotating drum (SD) and vortex shaker (VS) method. MN samples are classified according to their highest respirable mass index to the lowest obtained with the VS method.

5 Conclusion

Within this project two methods for characterizing the dustiness of nanomaterials in powder have been developed. With these two methods, measurements were made for the 15 nanomaterials available in the project.

The results of the present work suggest that:

- Mass- or number-based dustiness indices obtained varies with nanomaterials tested,
- A ranking is possible based on these different indices types,
- There are different dust generation rate time profiles. This difference in the dynamic of dust generation is reflected in the difference dustiness indices that are calculated.
- Both SD and VS methods gave reproducible results in terms of amount and size distribution of the generated particles for the MN samples in the project.
- All size distributions of as measured by the SD method were bi- or multimodal.
- Airborne particles generated during these tests are agglomerates/aggregates as shown by the few EM observations made on three selected MN. These results are in agreement with those of the existing literature.

Dustiness as quantified by particle number or by mass-based dustiness index had for both methods a large range. These findings suggest a corresponding large difference in exposure potential. It is however difficult to say more to the extent the relationship between index Dustiness and actual exposure is not known.

The comparison between the small drum and Vortex shaker shows that no significant correlation between the two can be found. Further evaluation of this method is needed in order to link it the standardized rotating drum method.

As written in the introduction, dustiness is not an intrinsic physical or chemical defined property of a powder, but its level depends on as well as characteristic properties of the powders and the activation energy in the simulated handling. Therefore different values may be obtained by different test methods (test apparatus, operation procedure, sampling and measurement strategy, *etc.*). It seems obvious that the absence of a harmonized approach concerning the measurement strategies and techniques, metrics and size ranges and the procedures of data analysis and reporting severely limits the comparison of these dustiness methods. Very little work has been done so far in this direction. Dustiness data obtained within this project can therefore contribute with information on the potential exposure risk level during powder handling (Schneider and Jensen, 2009). Number size distributions measured on the aerosols produced during the dustiness testing together with the few TEM pictures observed suggest that it is likely that occupational exposures are characterized by the presence of aggregates or agglomerates of the primary particles.

6 References

THIS REPORT IS BASED ON THE INTERIM PROJECT REPORTS AND DIRECT CONTRIBUTIONS FROM ALL CO-AUTHORS.

Baron PA & al. (2002) Evaluation of Aerosol Release During the Handling of Unrefined Single Walled Carbon Nanotube Material. NIOSH DART-02-191 December 2002

Brouwer D (2010) Exposure to manufactured nanoparticles in different workplaces. Toxicol. 29, 120

Isamu O, Hiromu S, Masashi G (2009) Dustiness testing of engineered nanomaterials. J. Phys.: Conf. Series 012003

Jensen KA, Clausen PA, Birkedal R, Kembouche Y, Christiansen E, Levin M, Koponen IK, Jacobsen NR, Håkan Wallin, H, de Temmerman P-J, Mast J, Guiot C, Spalla O, Motzkus C, Shivachev B, Rousset D,

Bau S, Witschger, O (2011a) - Standard operating procedures for characterization of the selected manufactured nanomaterials types. NANOGENOTOX deliverable report n°3: June 2011, 80 pp.

Jensen KA, Kembouche Y, Christiansen E, Jacobsen NR, Wallin H, Guiot C, Spalla O, Witschger O. (2011b) . Final Protocol for producing suitable manufactured nanomaterial exposure media. NANOGENOTOX deliverable report n°2: July 2011 31 pp.

Kim SH, Mulholland GW, Zachariah MR (2009) Density measurement of size selected multiwalled carbon nanotubes by mobility-mass characterization. Carbon, 47, 1297-1302.

Liden G (2006) Dustiness testing of materials handled at workplaces. AOH, 50, 437

OECD (2012) Important issues on risk assessments of manufactured nanomaterials. ENV/JM/MONO(2012)8

Olferta JS, Symonds JPR, Collings N (2007) The effective density and fractal dimension of particles emitted from a light-duty diesel vehicle with a diesel oxidation catalyst. J. Aerosol Sci, 38, 69-82.
RIP-oN 2 (2011) Specific Advice on Fulfilling Information Requirements for Nanomaterials under REACH.

Schneider T and Jensen KA (2008) Combined single drop and rotating drum dustiness test of fine to nanosized powders using a small drum. Annals of Occupational Hygiene 52/1: 23-34.

Schneider T and Jensen KA (2009) Relevance of aerosol dynamics and dustiness for personal exposure to manufactured nanoparticles. J Nanopart Res 11:1637–1650

Spalla O, Lyonnard S, and Testard F (2003) Analysis of the small-angle intensity scattered by a porous and granular medium. Journal of Applied Crystallography 36: 338-347.

Teleki A, Wengeler R, Wengeler L, Nirschl H, Pratsinis SE (2008) Distinguishing between aggregates and agglomerates of flame-made TiO₂ by high pressure dispersion, Powder Technol 181, 292-300

Witschger O, Wrobel R, Gaffet E, Coste S (2007) Evaluation of aerosol release during high-energy ball milling of metallic oxide powders ». In : Proceedings of the 3rd NanoEH, Taipei, Taiwan

Witschger O, Brouwer D, Jensen JA, Koponen IK, Berges M, Jankowska E., Dahman D., Burdett G, Bard D (2011) DUSTINANO: A PEROSH initiative towards a harmonized approach for evaluating the dustiness of nanopowders. 5th International Symposium on Nanotechnology, Occupational and Environmental Health August 9 - August 12, 2011 — Boston, MA, USA, In abstract book, p178.





• Contact •

Website:

www.nanogenotox.eu

E-mail:

nanogenotox@anses.fr

Coordinator: French Agency for Food, Environmental and Occupational Health & Safety (ANSES)

27-31, avenue du Général
Leclerc
94701 Maisons-Alfort Cedex
France



Partners

French Agency for Food, Environmental and Occupational Health Safety (France)	ANSES	
Federal Institute of Risk Assessment (Germany)	BfR	
French Atomic Energy Commission (France)	CEA	
Institute of Mineralogy and Crystallography (Bulgaria)	IMC-BAS	
Veterinary and Agrochemical Research Centre (Belgium)	CODA-CERVA	
Finnish Institute of Occupational Health (Finland)	FIOH	
Roumen Tsanev Institute of Molecular Biology Academy of Sciences (Bulgaria)	IMB-BAS	
Institut national de recherche et de sécurité (France)	INRS	
National Health Institute Doutor Ricardo Jorge (Portugal)	INSA	
Scientific Institute of Public Health (Belgium)	IPH	
Institut Pasteur of Lille (France)	IPL	
Istituto superiore di sanità (Italy)	ISS	
The Nofer institute of Occupational Medicine (Poland)	NIOM	
National Research Centre for the Working Environment (Denmark)	NRCWE	
National Institute for Public Health and the Environment (The Netherlands)	RIVM	
Universitat Autònoma de Barcelona (Spain)	UAB	

This document arises from the NANOGENOTOX Joint Action which has received funding from the European Union, in the framework of the Health Programme under Grant Agreement n°2009 21. This publication reflects only the author's views and the Community is not liable for any use that may be made of the information contained therein.



Co-funded by the Health Programme of the European Union